

# SLP2-322

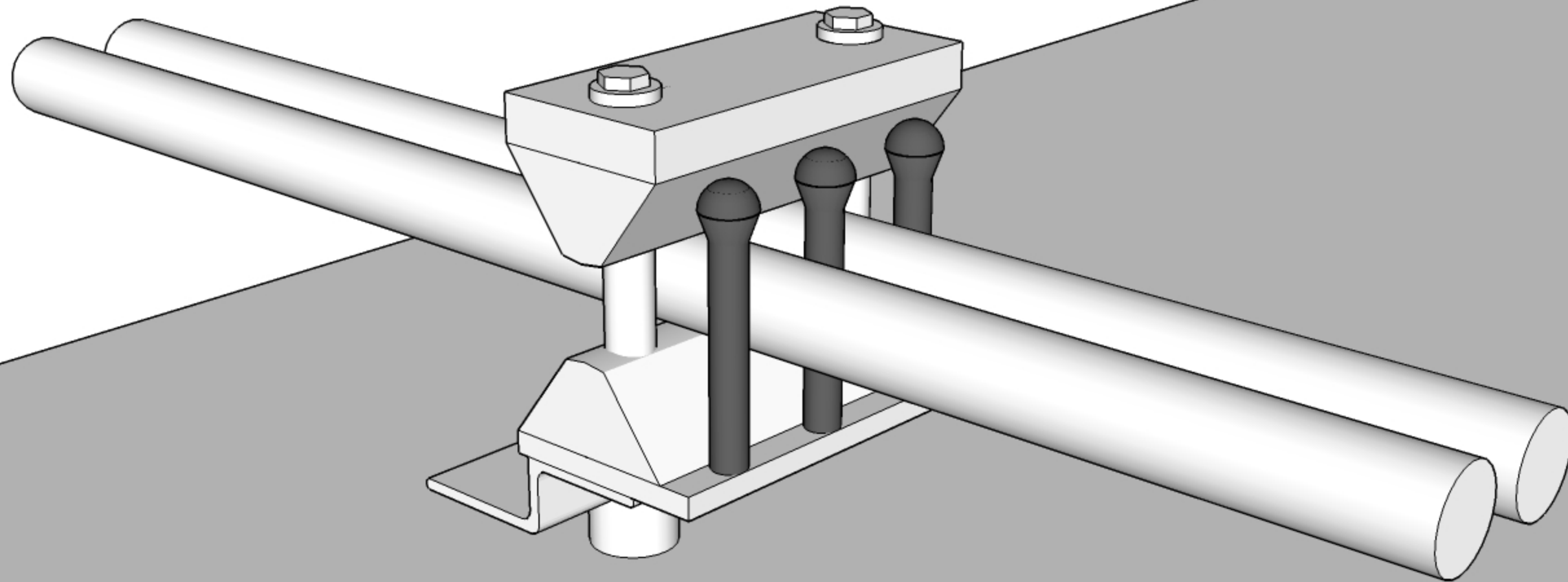

T-SEP Configuration:  
2 1/4" SLP-2  
1/2" Dia. Tubes  
2 Tubes  
2 1/4" Assembly I.D.  
1 13/16" Assembly Height  
2 Hardware Access Holes