

SLP2-422

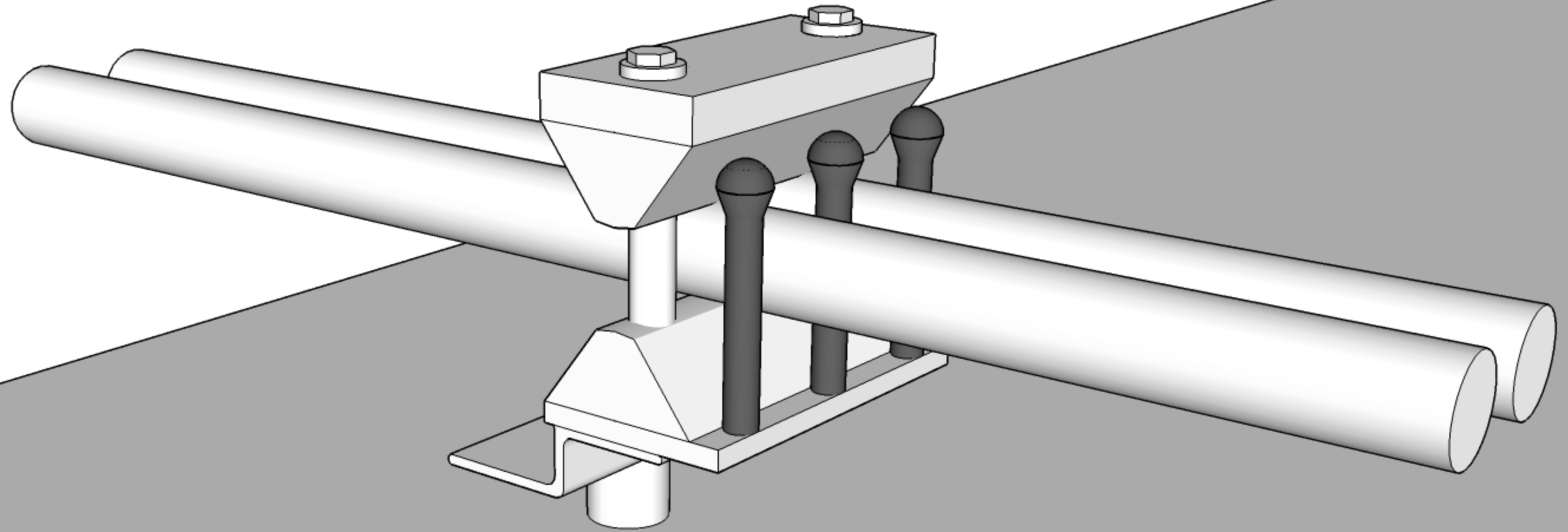

T-SEP Configuration:
2 1/4" SLP-2
9/16" Dia. Tubes
2 Tubes
2 1/4" Assembly I.D.
1 7/8" Assembly Height
2 Hardware Access Holes