

SLP2-512

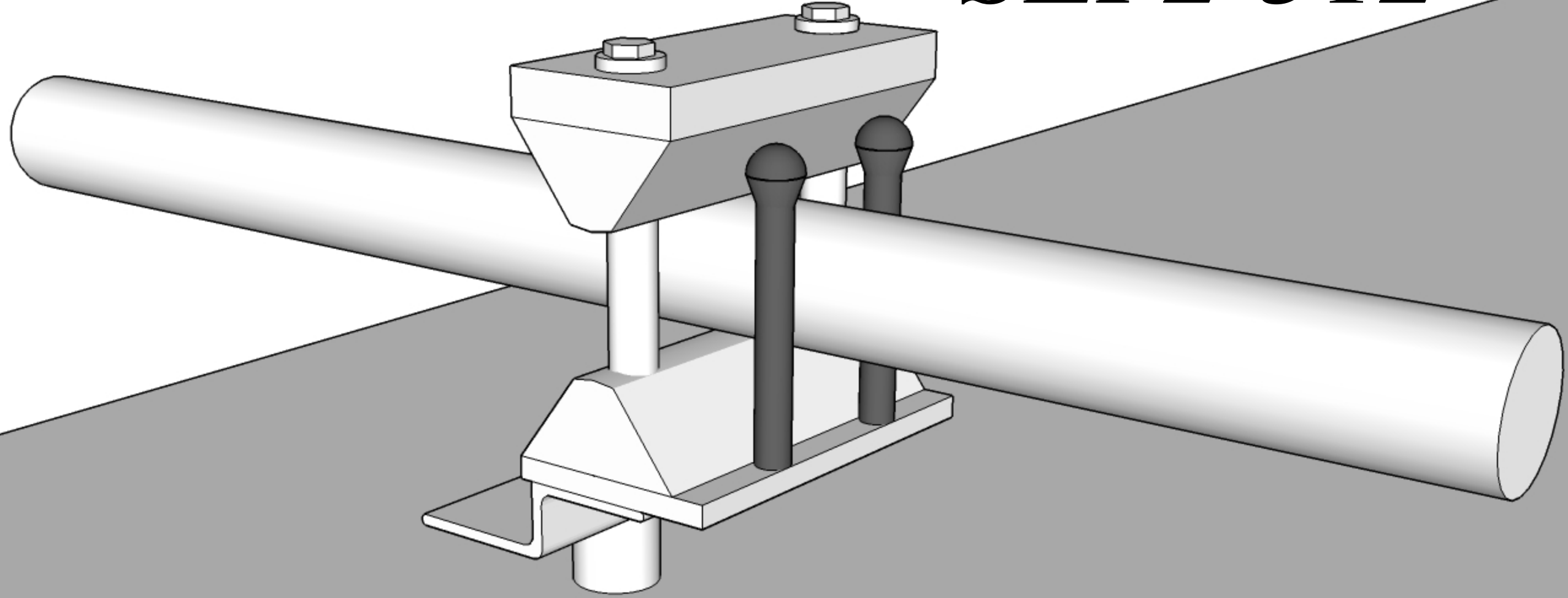

T-SEP Configuration:
2 1/4" SLP-2
3/4" Dia. Tubes
1 Tubes
2 1/4" Assembly I.D.
2 3/16" Assembly Height
2 Hardware Access Holes