

SLP8-292

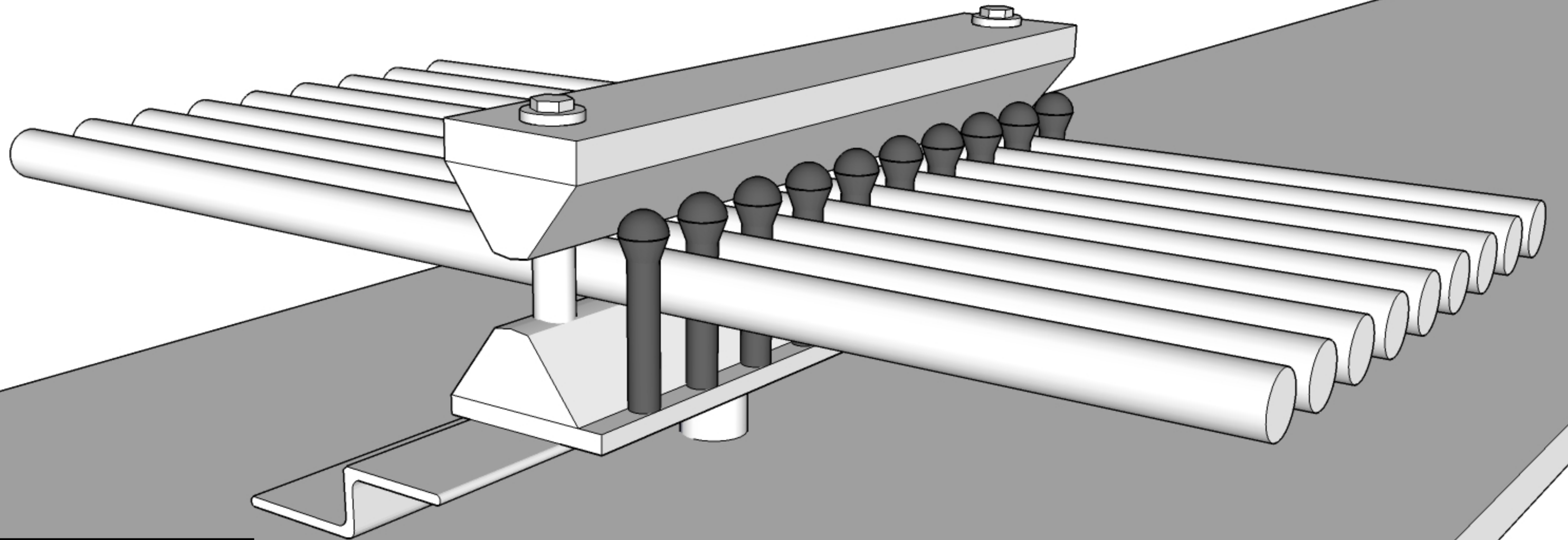

T-SEP Configuration:
8" SLP-8
3/8" Dia. Tubes
9 Tubes
6" Assembly I.D.
1 11/16 " Assembly Height
2 Hardware Access Holes