

# T-SEP636-2NM

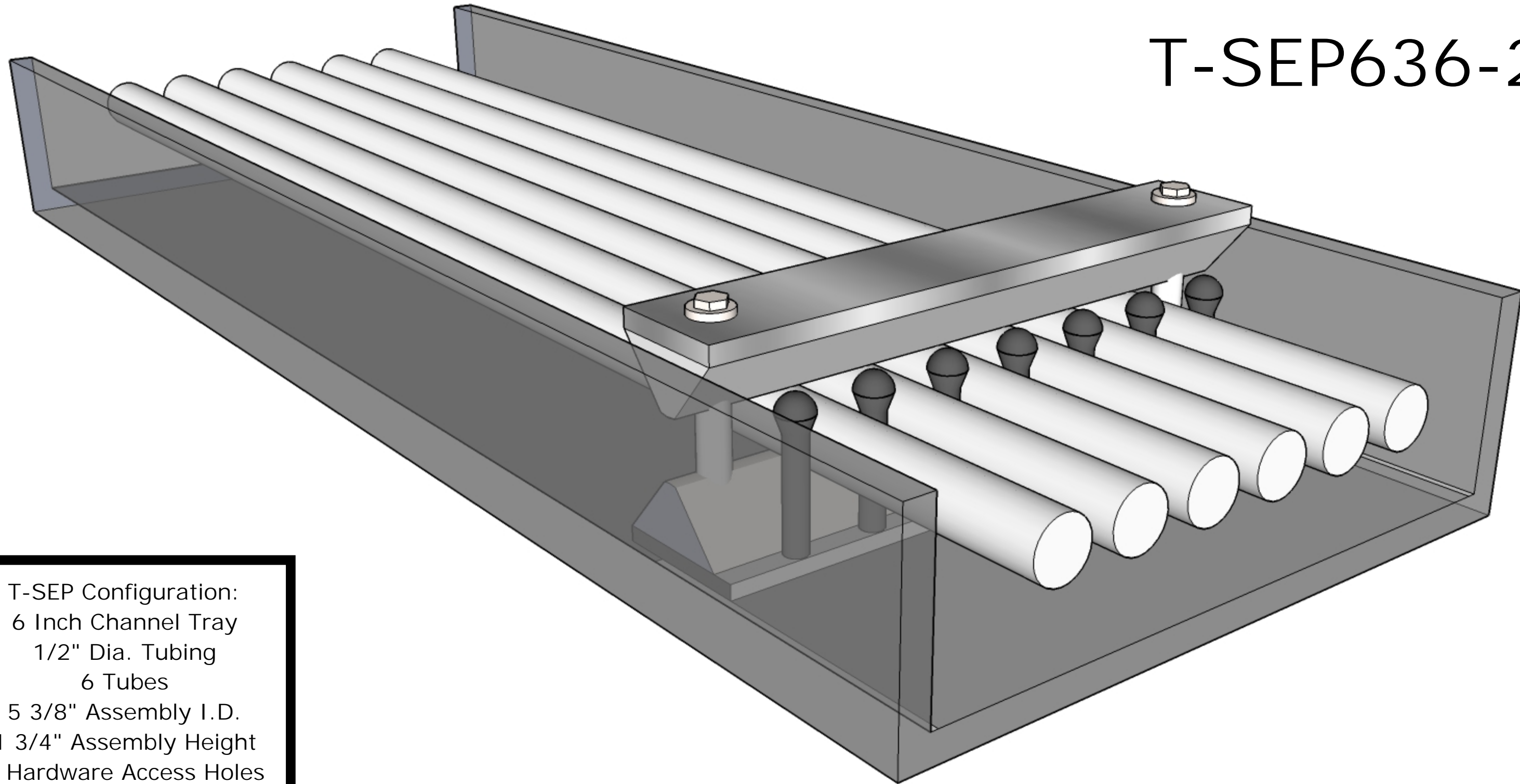

T-SEP Configuration:  
6 Inch Channel Tray  
1/2" Dia. Tubing  
6 Tubes  
5 3/8" Assembly I.D.  
1 3/4" Assembly Height  
2 Hardware Access Holes