

T-SEP433-2NM

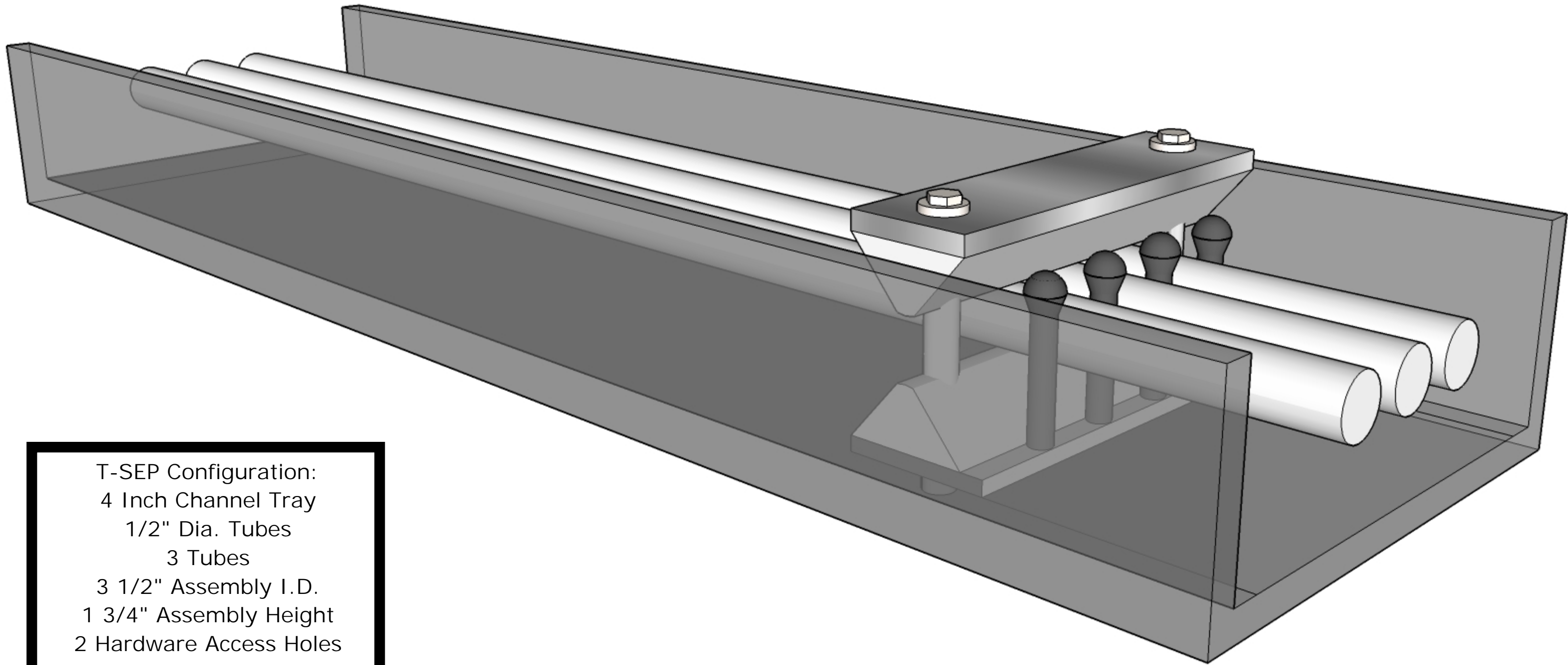

T-SEP Configuration:
4 Inch Channel Tray
1/2" Dia. Tubes
3 Tubes
3 1/2" Assembly I.D.
1 3/4" Assembly Height
2 Hardware Access Holes