

T-SEP443-2NM

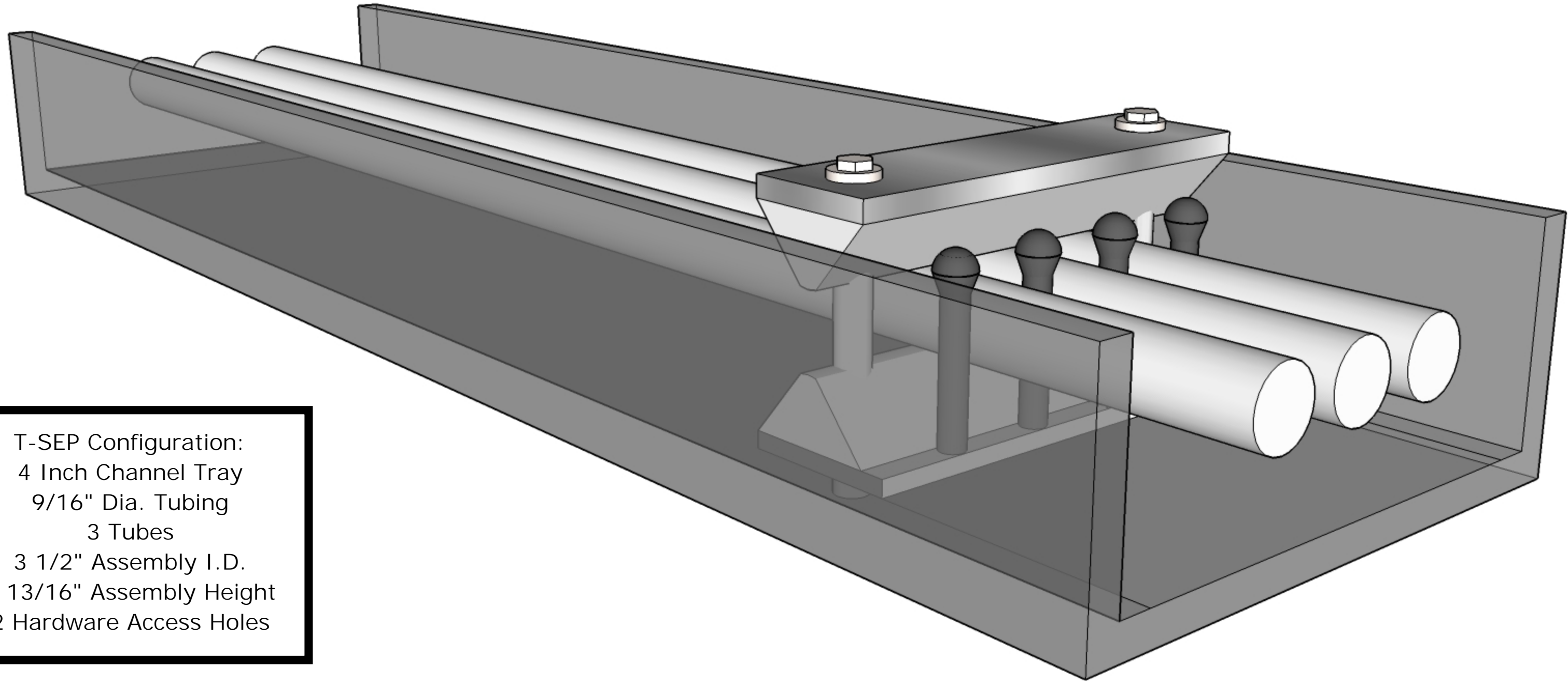

T-SEP Configuration:
4 Inch Channel Tray
9/16" Dia. Tubing
3 Tubes
3 1/2" Assembly I.D.
1 13/16" Assembly Height
2 Hardware Access Holes