

# T-SEP416-2NM

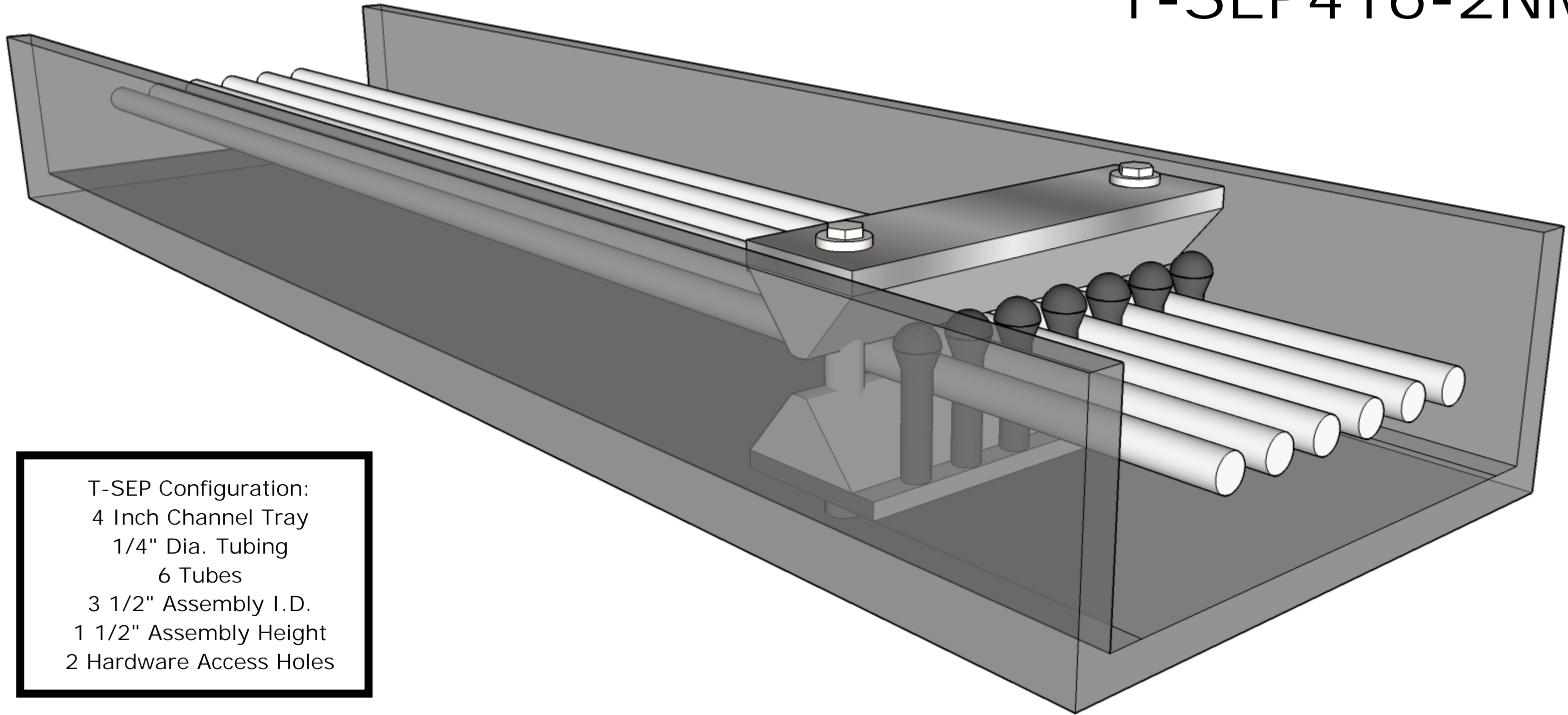

T-SEP Configuration:  
4 Inch Channel Tray  
1/4" Dia. Tubing  
6 Tubes  
3 1/2" Assembly I.D.  
1 1/2" Assembly Height  
2 Hardware Access Holes