

T-SEP313-2NM

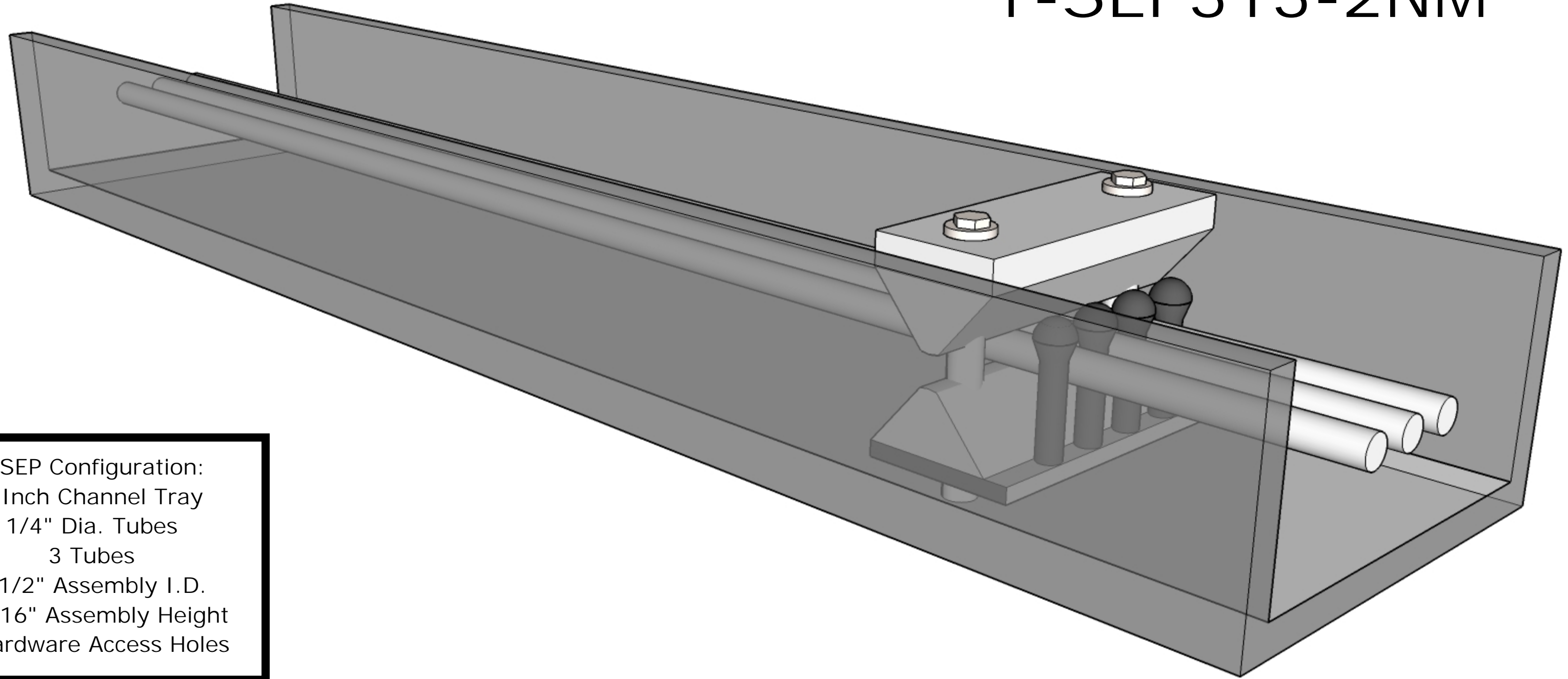

T-SEP Configuration:
3 Inch Channel Tray
1/4" Dia. Tubes
3 Tubes
2 1/2" Assembly I.D.
1 9/16" Assembly Height
2 Hardware Access Holes