

# T-SEP628-2NM

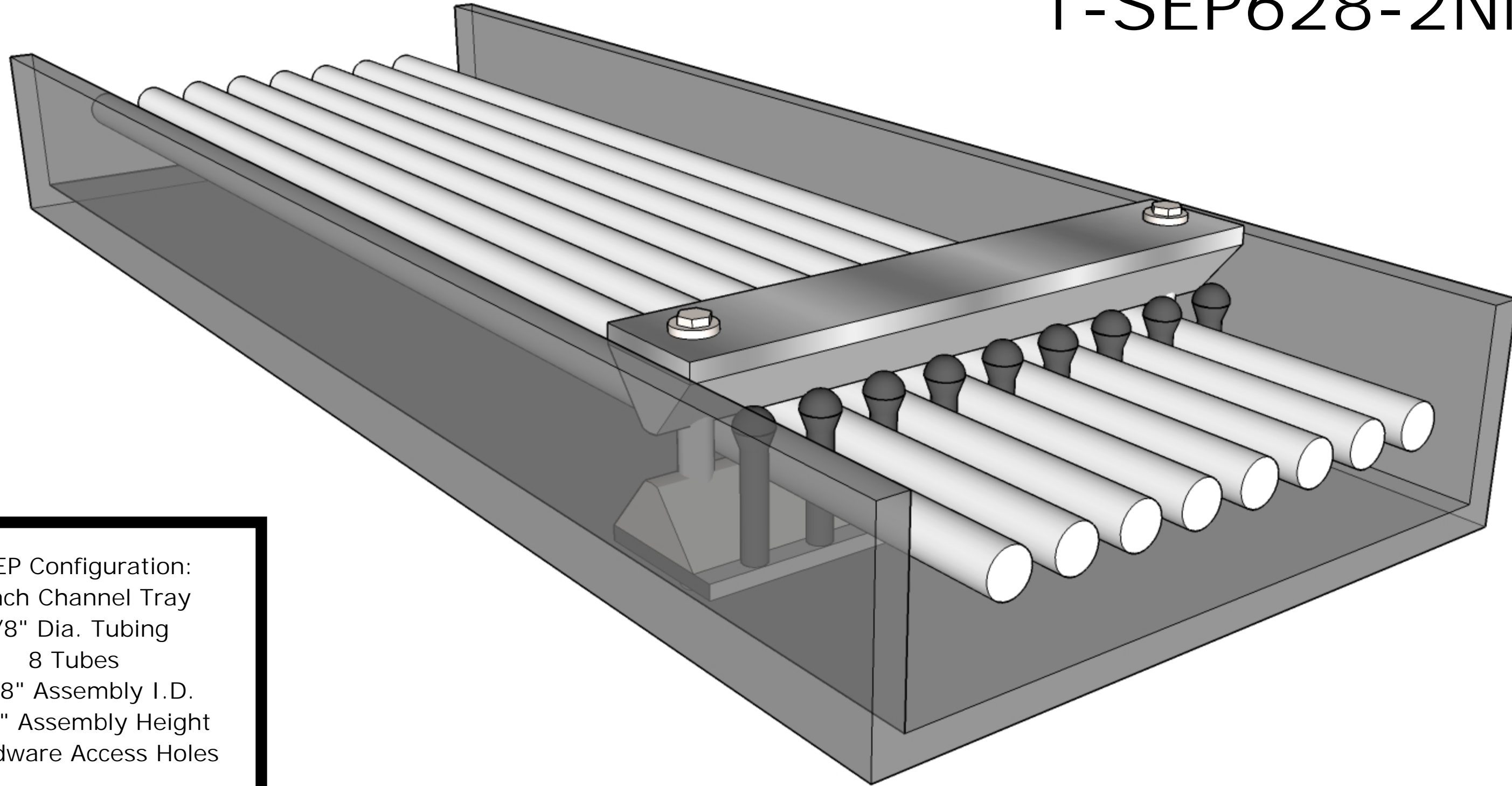

T-SEP Configuration:  
6 Inch Channel Tray  
3/8" Dia. Tubing  
8 Tubes  
5 3/8" Assembly I.D.  
1 5/8" Assembly Height  
2 Hardware Access Holes