

T-SEP424-2NM

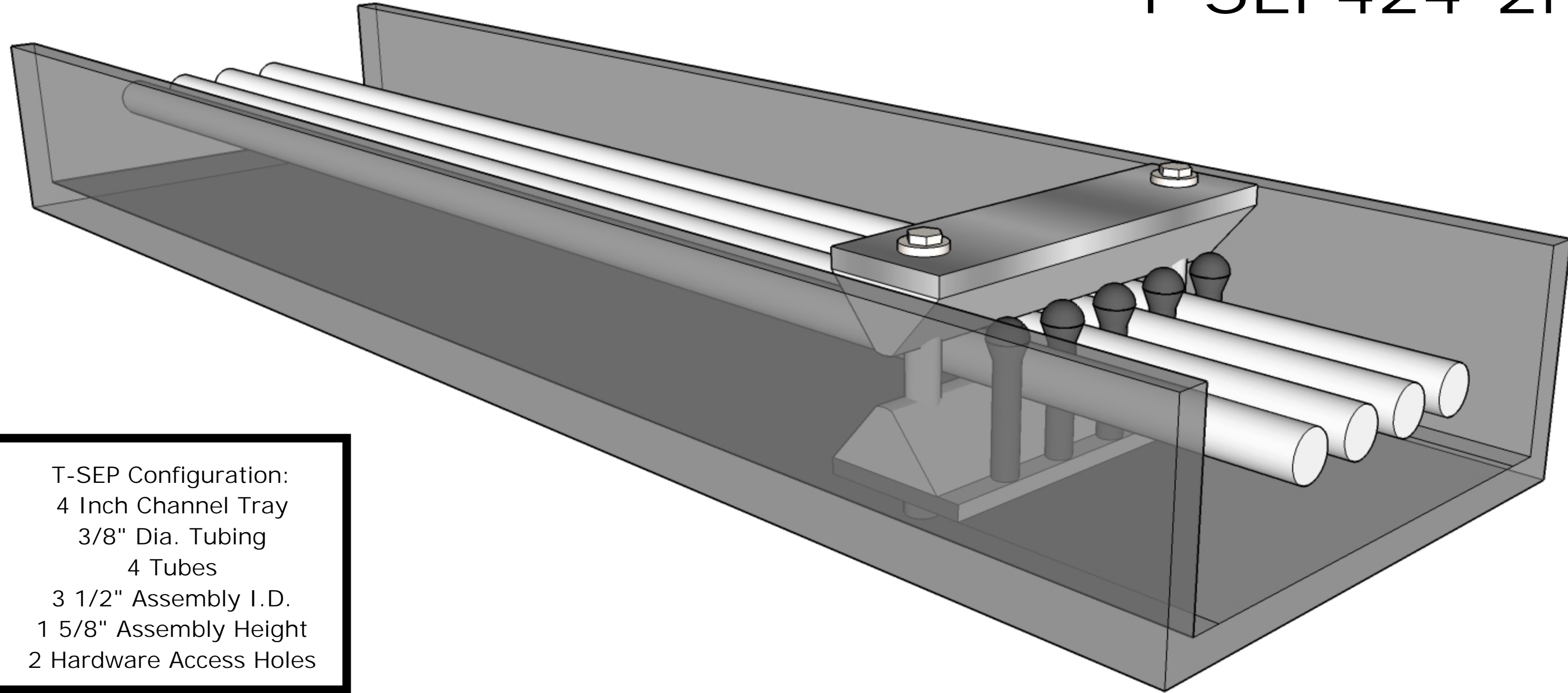

T-SEP Configuration:
4 Inch Channel Tray
3/8" Dia. Tubing
4 Tubes
3 1/2" Assembly I.D.
1 5/8" Assembly Height
2 Hardware Access Holes