

T-SEP322-2NM

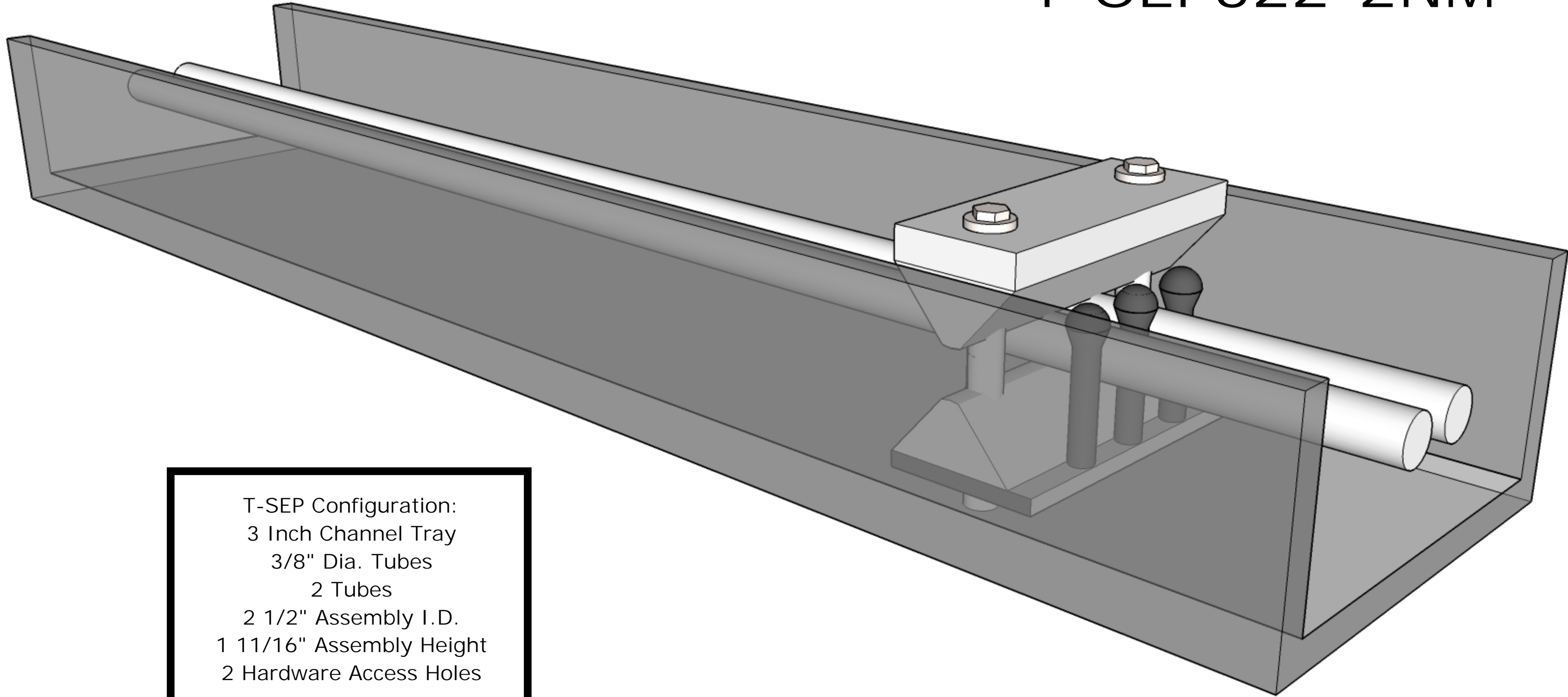

T-SEP Configuration:
3 Inch Channel Tray
3/8" Dia. Tubes
2 Tubes
2 1/2" Assembly I.D.
1 11/16" Assembly Height
2 Hardware Access Holes