

T-SEP452-2NM

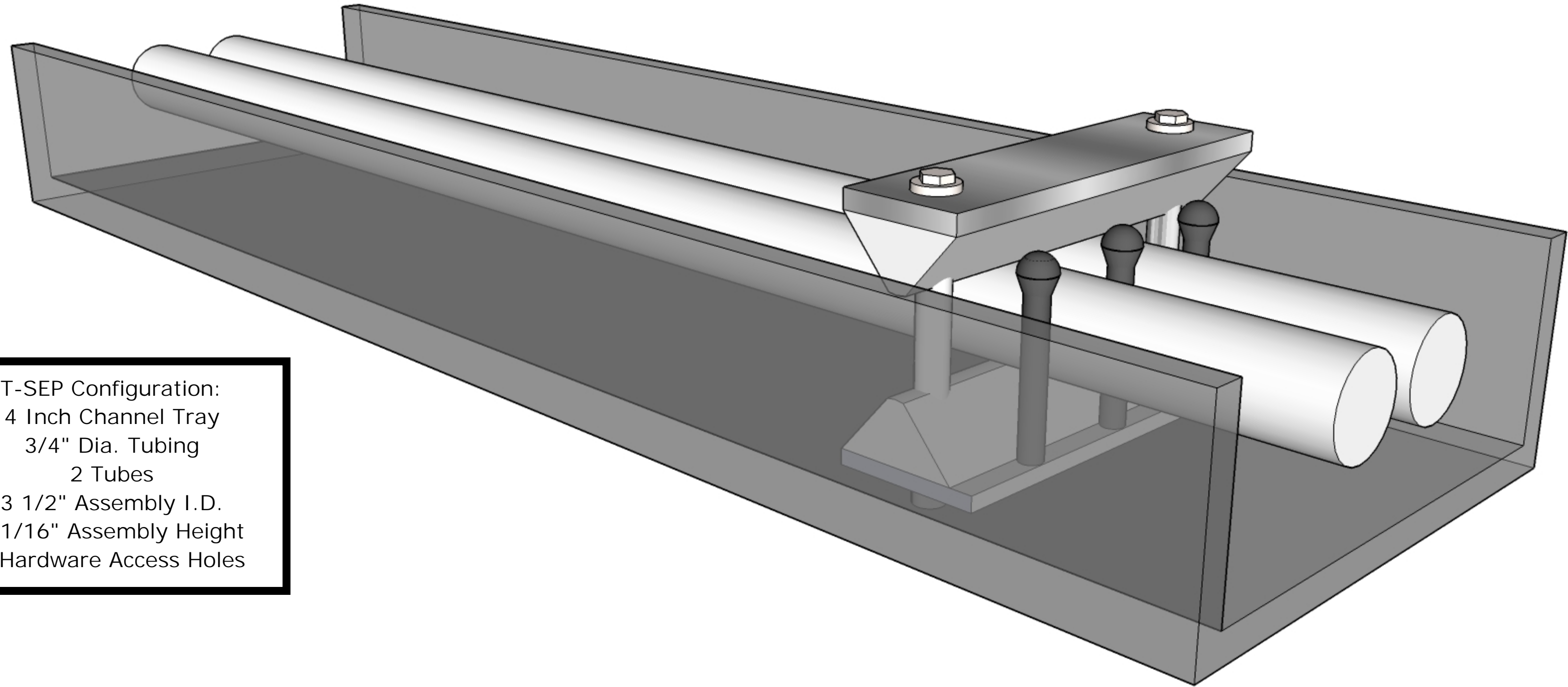

T-SEP Configuration:
4 Inch Channel Tray
3/4" Dia. Tubing
2 Tubes
3 1/2" Assembly I.D.
2 1/16" Assembly Height
2 Hardware Access Holes